

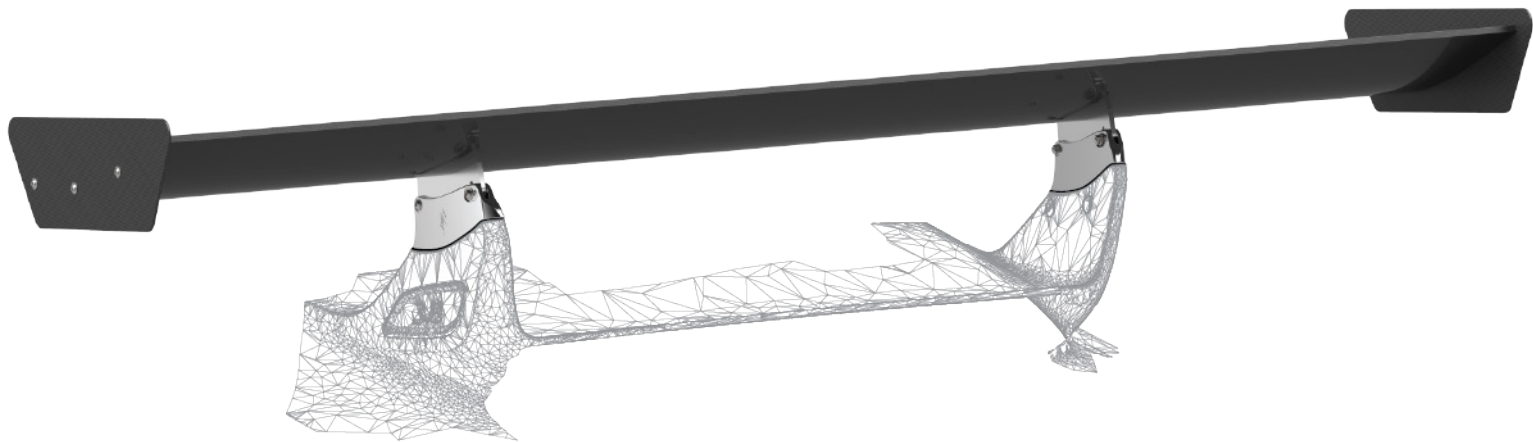

SAVVY

S.991.1.GT3.100



SAVVY Aero Products

S.991.1.GT3.100

Who is SAVVY?

SAVVY LLC was founded in 2016 in San Francisco, CA. Our mission is to create products that not only function as efficiently as possible, but are designed to enhance the original intended design of the car. All our products are designed from the ground up using the latest technologies. Full focus is put into every aspect of development to ensure we have products of the highest quality. Every design has been thoroughly tested on multiple platforms and multiple racing conditions to ensure the products we create can fully represent our brand. We are excited to have you as a customer and look forward to bringing you faster lap times.

Contents

Introduction	2 - 3
GT3 Rear Spoiler Removal Instruction	4 - 7
S.991.1.GT3.100 Part List	8 - 9
S.991.1.GT3.100 Installation Guide	10 - 17

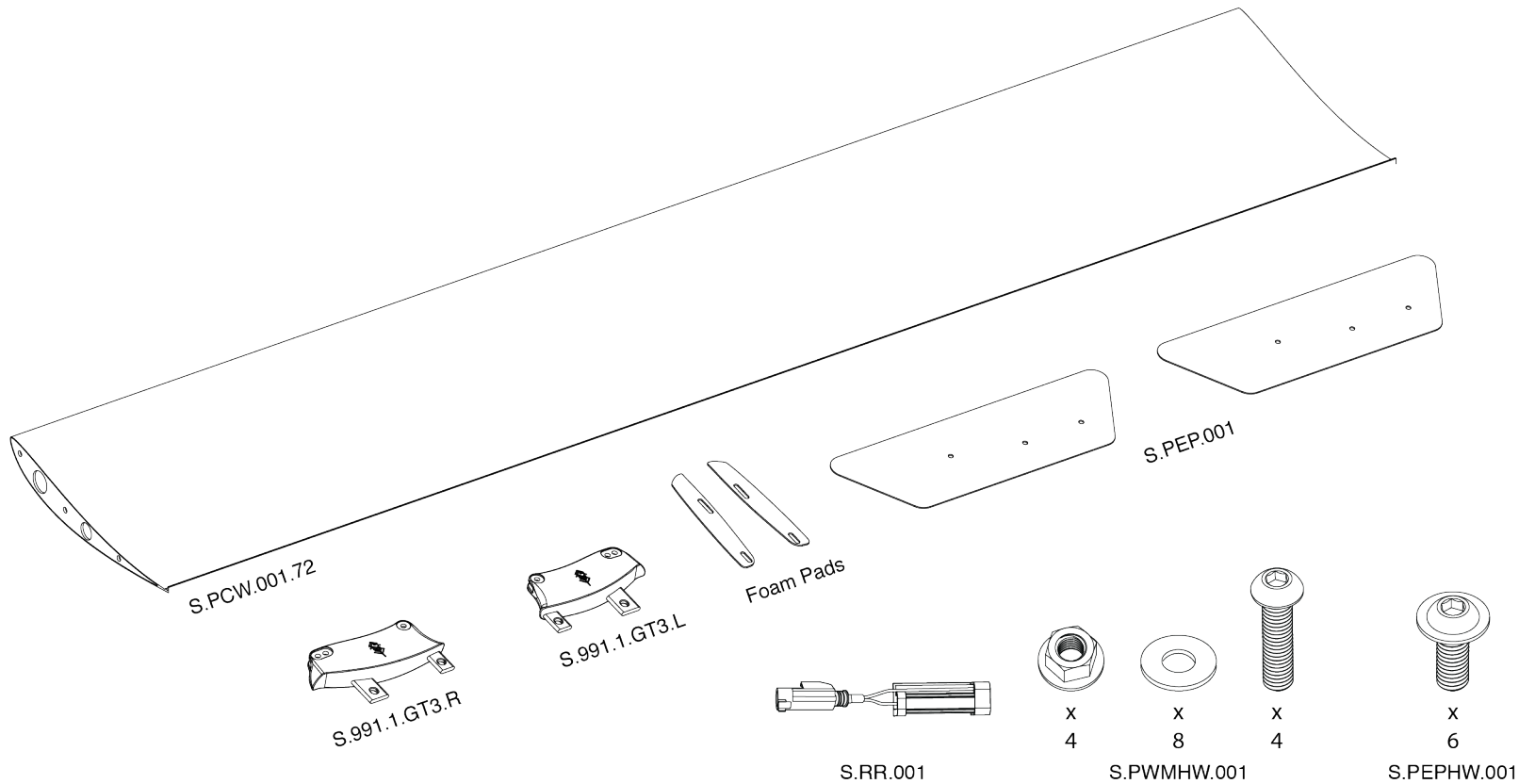

Tools needed to assemble:

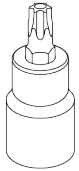

Torx Socket
1/4" Drive, T40

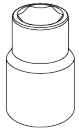

Standard Socket
1/4" Drive, 10 mm



Click Torque Wrench
1/4" Drive
40-200 IN / LBS

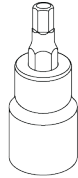

Allen Hex Socket
1/4" Drive, 4 mm



Ratchet Wrench
1/4 Drive

S.991.1.GT3.100 Wing Kit

SAVVY Carbon Fiber Wing 72"	S.PCW.001.72
SAVVY Wing Mounts	S.991.1.GT3.L
	S.991.1.GT3.R
SAVVY End Plates	S.PEP.001
SAVVY Wing Mount Hardware	S.PWMHW.001
SAVVY End Plates Hardware	S.PEPHW.001
SAVVY Resistor	S.RR.001
Foam Pads	

For warranty information, please visit savvylc.co.

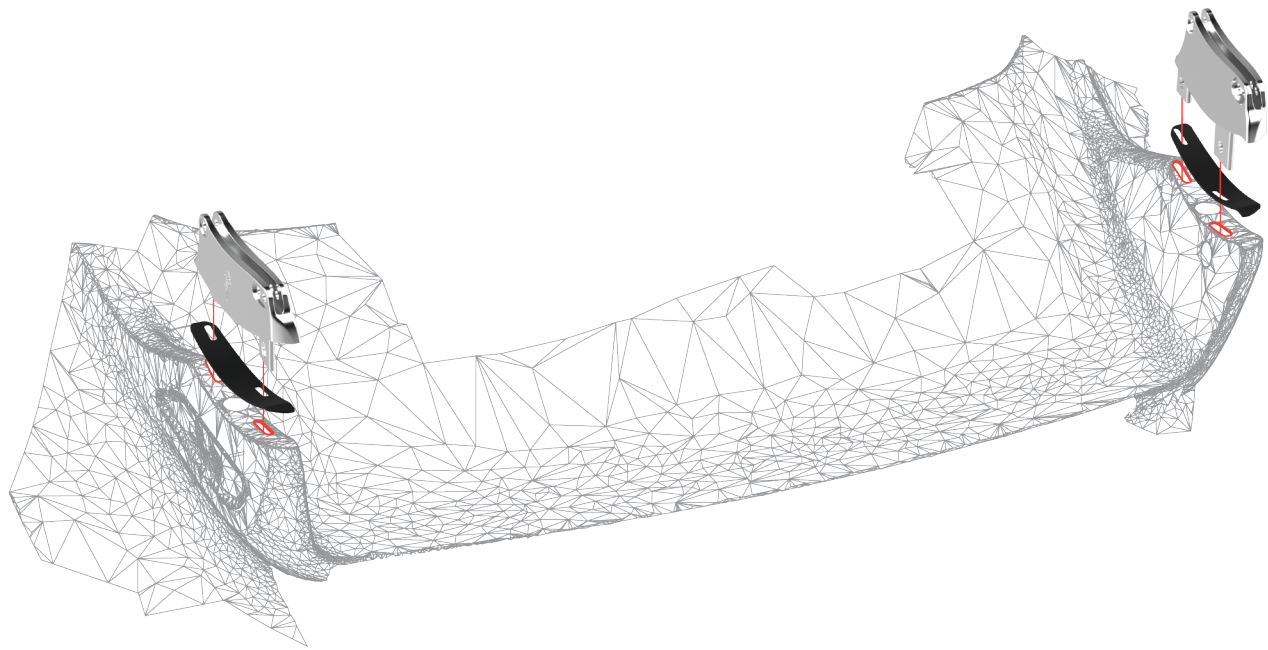

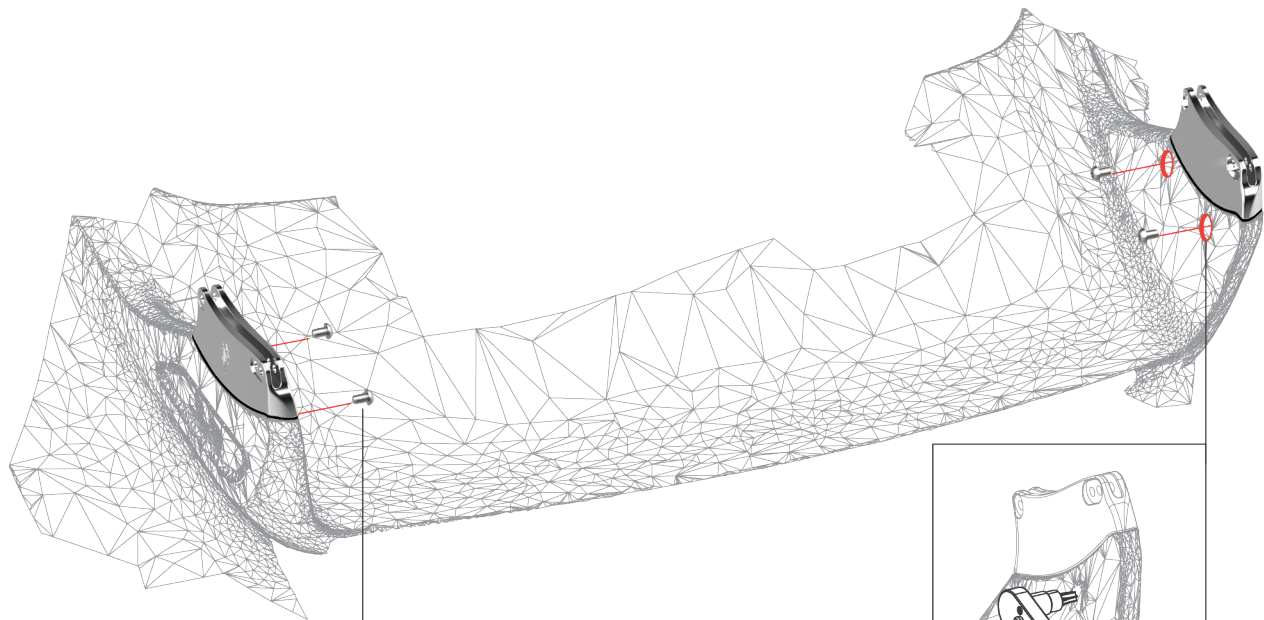

Reserved Factory Screws

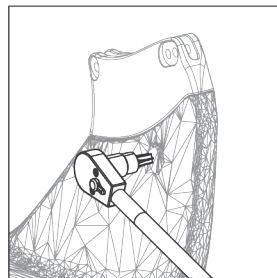

Tighten Halfway
17 Nm, 156 IN / LBS

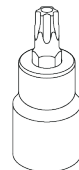

Torx Socket
1/4" Drive, T40

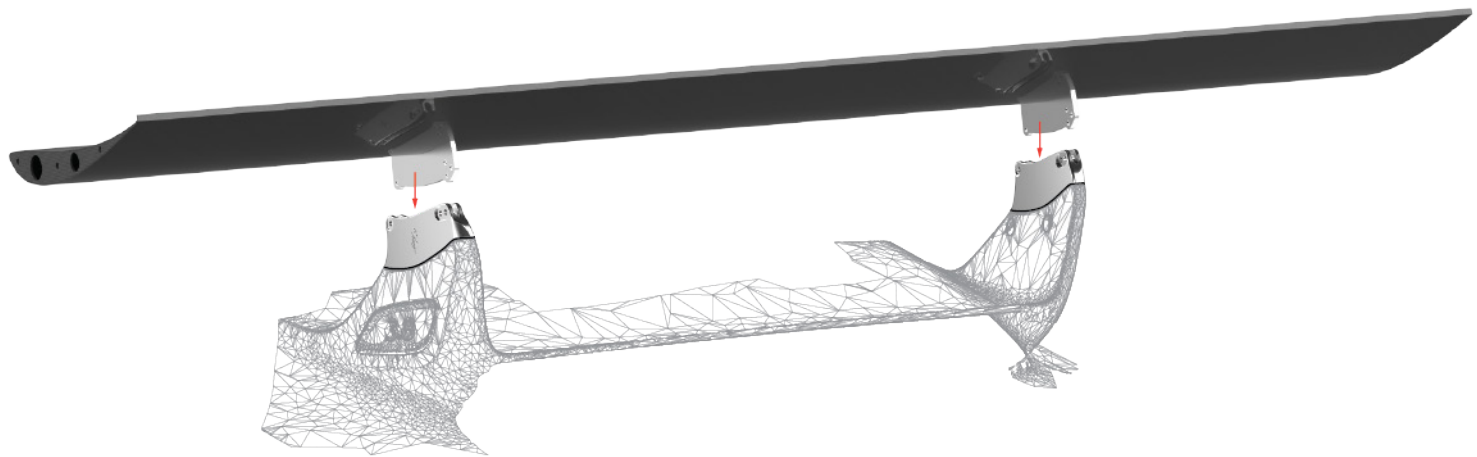

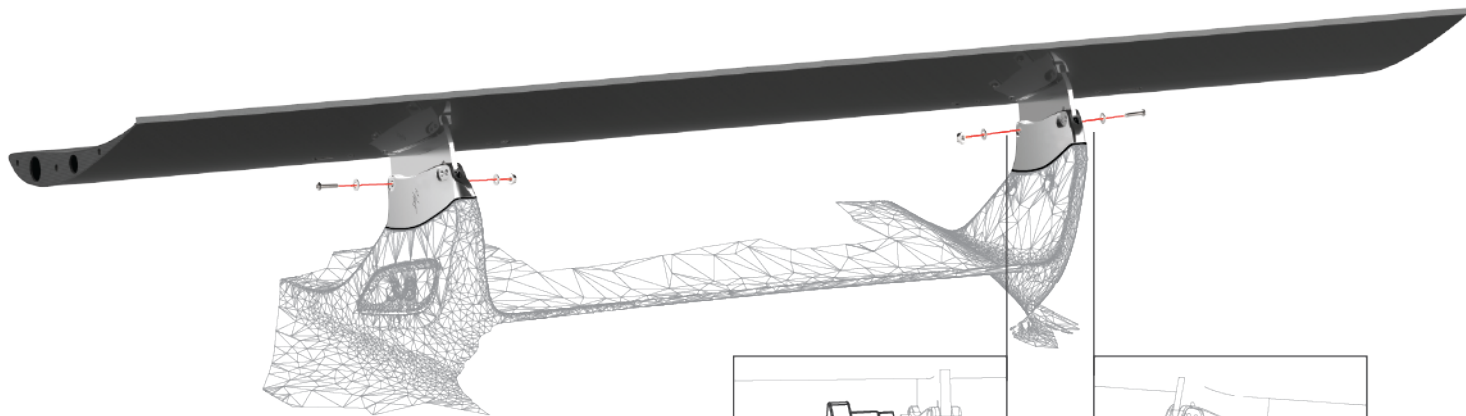

x
2



x
4



x
2

S.PWMHW.001



Standard Socket
1/4" Drive, 10 mm

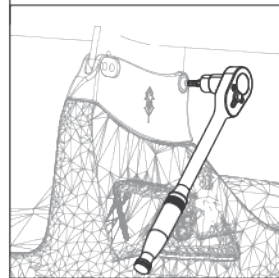
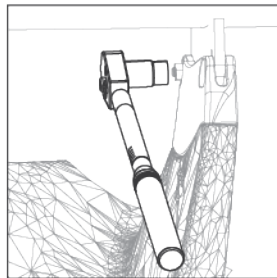

Tighten
16.27 Nm, 144 IN / LBS



Allen Hex Socket
1/4" Drive, 4 mm

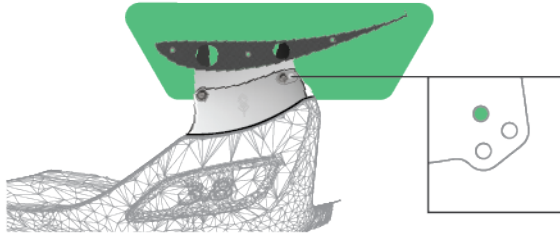

EFFICIENT

Maximum efficiency of downforce to drag. Free Flow CFD estimate 240lbs of downforce at 100mph.

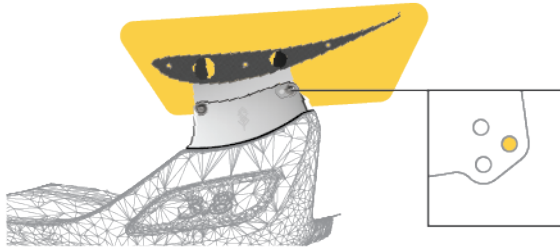

MODERATE

More downforce and a slight increase in drag. Free Flow CFD estimate 295lbs of downforce at 100mph.

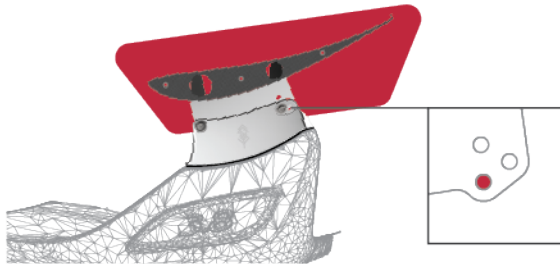

MAX

Maximum downforce and a slight increase in drag. Free Flow CFD estimate 368lbs of downforce at 100mph.

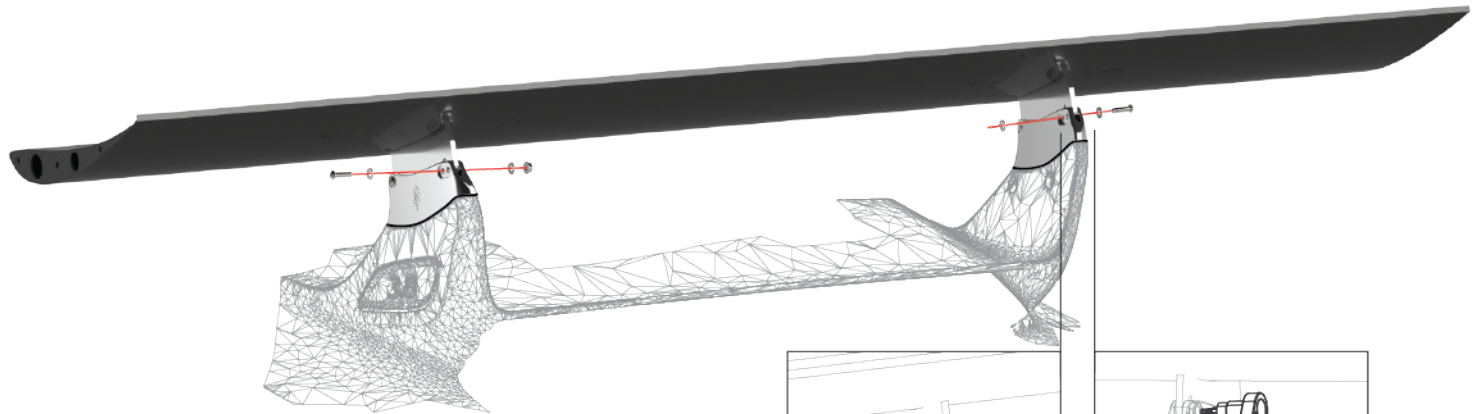

x
2



x
4



x
2

S.PWMHW.001



Standard Socket
1/4" Drive, 10 mm

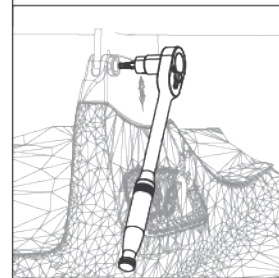
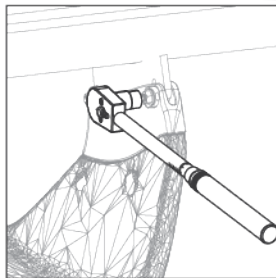

Tighten
16.27 Nm, 144 IN / LBS

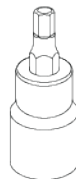

Allen Hex Socket
1/4" Drive, 4 mm

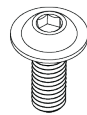
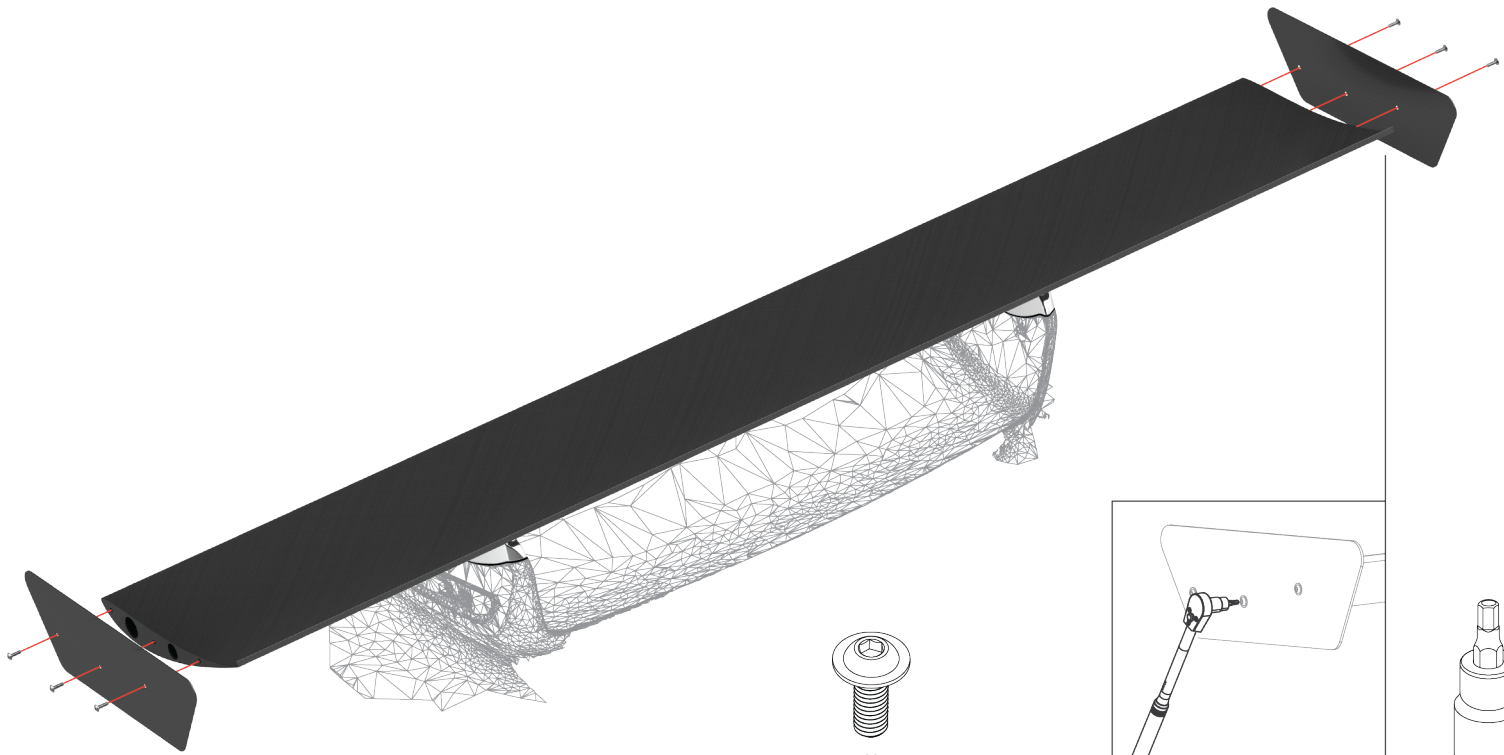

x
6

S.PEPHW.001

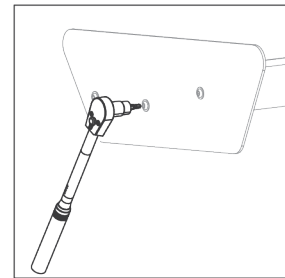

Tighten
10.85 Nm, 96 IN / LBS

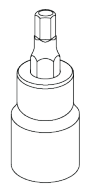

Allen Hex Socket
1/4" Drive, 4 mm

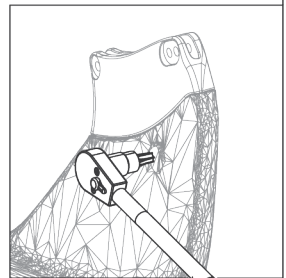
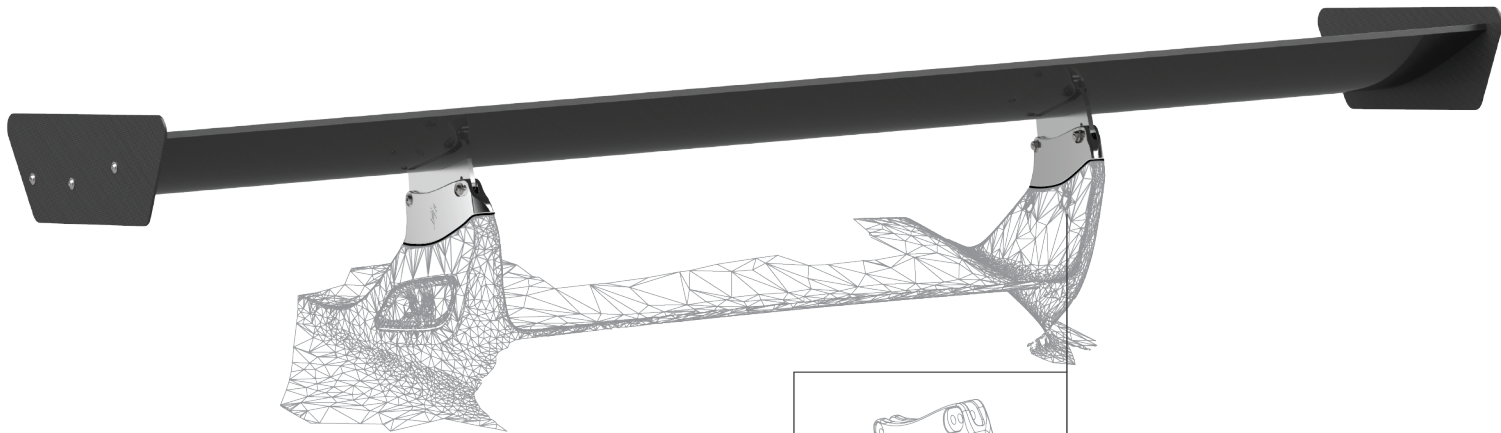

Tighten
17 Nm, 156 IN / LBS

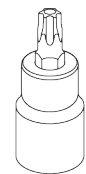

Torx Socket
1/4" Drive, T40

savvyllc.co